

vtf®

Superficies
Sólidas

PRODUCTO
2021

ÍNDICE

1.- ¿QUIENES SOMOS ?	3
2.- SUPERFICIE SÓLIDA	8
3.- PROPIEDADES	10
4.- LAVABOS Serie SUAU	
RABE	12
CLOT	14
CLOT ON TOP	16
NOA	18
FUSION	20
SLOW	22
5.- LAVABOS ENCASTRADOS	
ESTANDAR	24
6.- ACCESORIOS	27
7.- BAÑERAS DE ENCASTRE	
UNIQUE	32
3-WAY	33
BASIC	34
BABYBATH	35

¿QUIENES
SOMOS?

1.



vf Superficies
Sólidas[®]



**GOLD ASSOCIATE
FABRICATOR**

by PORCELANOSA

CREATIVIDAD TÉCNICA EN PROYECTOS DE DISEÑO



▶ Nuestro eslogan describe en buena parte el servicio que ofrecemos a nuestros clientes y colaboradores.

En VF realizamos todo tipo de diseños con superficies sólidas de las mejores marcas. Gracias a la colaboración con los grandes fabricantes del sector, ofrecemos las garantías y certificados exigidos a nivel mundial.





¿QUIENES SOMOS?

1.

En **VF** disponemos de un equipamiento técnico y humano preparado para realizar cualquier tipo de proyecto ofreciendo la mejor calidad y garantías.

Contamos con una plantilla que aporta la experiencia, abalada con más de 30 años de trabajo para los clientes más exigentes, todos ellos han contribuido a nuestra empresa otorgándole un valor diferenciador, que no es más que la pasión por el trabajo bien hecho.

Disponemos de hornos, prensas de vacío e hidráulicas de gran formato y máquinas de fresado por control numérico CNC, las cuales nos permiten realizar todo tipo de formas y cortes con la mayor precisión del mercado.



NUESTROS LOGROS

1.

Internacionalización.

Trabajamos a nivel nacional e Internacional, hemos realizado proyectos en varios países como Batumi (Georgia), Cannes (Francia), Bologna (Italia), Milan (Italia), Lisboa (Portugal), Baku (Azerbaijan) Daka (Banglades). Además recibimos encargos de los 5 continentes.

Premio de ORO ADCV de Mobiliario y equipamiento de cocina y baño.

Nuestra tierra también nos reconoce al otorgarnos el premio mas importante de diseño de la comunidad Valenciana.

Aprobación Patente Europea.

Hace 5 años y de la mano del diseñador **Fran Canos Estudio** decidimos apostar fuerte por la investigación y el desarrollo de nuevos conceptos. Lo conseguimos creando la primera grifería de solid que se une a la encimera sin ningún tipo de juntas.



Premio red dot (Alemania).

Ganadores sección internacional de grifería. Nuestro mayor logro hasta la fecha, ha sido ganar recientemente el mayor premio internacional de diseño eso nos convierte en la primera empresa del sector en conseguirlo.



CLIENTES

1.

▶ NUESTROS CLIENTES, NUESTRA MEJOR GARANTÍA.

Trabajamos con empresas que buscan transformar mediante el diseño la forma en que nos relacionamos con nuestro mundo. Empresas que buscan la excelencia desde el inicio de proyecto.

VF ofrece las mejores soluciones en todas las partes del proceso.



PORCELANOSA



IBEROSTAR★
HOTELS & RESORTS



nh
HOTELES

DRAGADOS

QUE PODEMOS HACER POR TÍ, EN VF® SUPERFICIES SÓLIDAS.

En **VF** podemos acompañarte de principio a fin en tu proyecto. Las características que aporta la superficie sólida nos permiten realizar revestimientos interiores y exteriores, productos finales, mobiliario, señalética, encimeras de cocina, equipamiento de baño... El límite lo pones tu.



**GOLD ASSOCIATE
FABRICATOR**

by PORCELANOSA

SUPERFICIE SÓLIDA

2.

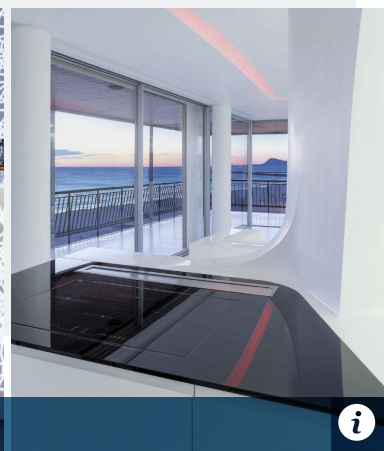

▼ MÁXIMAS CERTIFICACIONES A NIVEL MUNDIAL

Es un material ecológico, ya que puede reciclarse al 100%. Todo producto fabricado con Superficie Sólida puede ser reprocesado y utilizado de nuevo en su ciclo de producción.

SUPERFICIE SÓLIDA 2.



PROPIEDADES DEL MATERIAL

PROPIEDADES 3.

Estética + Funcionalidad



Termoformable



Sin juntas



Fácil de limpiar



Garantía 10 años

Funcionalidad



Reparable



Impermeable



Antibacterias



Alta durabilidad



100% Reciclable



Contacto con alimentos



No poroso



Resistente al impacto



Resistencia al fuego (Euroclase B-s1-d0)



Resistente a productos abrasivos

Estético



Diseño personalizado



Blancura intensa



Agradable al tacto



Retroiluminado

Propiedades K-LIFE



Purificación de aire



Bactericida



Eliminación de productos químicos



LAVABOS
TERMOFORMADOS

LAVABOS

4.



vf Superficies
Sólidas

Serie SUAU

RABE

45,9x30,6 cm / 68,5x30,6 cm / 99,9x30,6 cm

4.





made with
KRICN

RABE

45,9x30,6 cm / 68,5x30,6 cm / 99,9x30,6 cm

4.

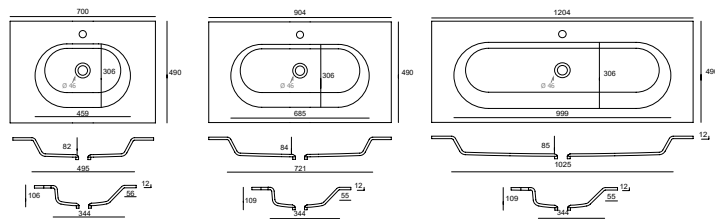

K-LIFE



Centrado

Doble

Desplazado

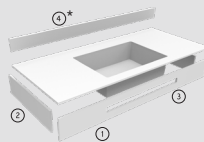
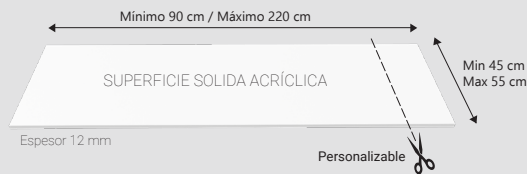

- ① Altura máxima 12 cm
- ② Altura máxima 12 cm
- ③ Toallero CNC 60 cm
- ④* Altura máxima 10 cm

④* Detalle





CLOT

47,9 x 31,1 cm

4.



CLOT

47,9 x 31,1 cm

4.

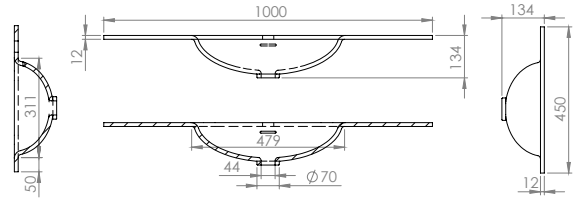

made with
KRION

K-LIFE



Centrado

Doble

Desplazado

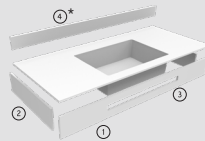
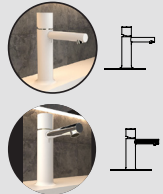
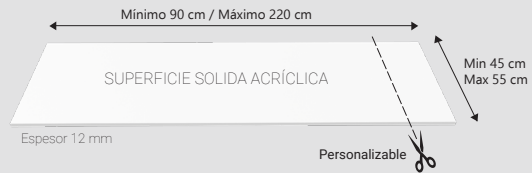

- ① Altura máxima 12 cm
- ② Altura máxima 12 cm
- ③ Toallero CNC 60 cm
- ④* Altura máxima 10 cm

④* Detalle

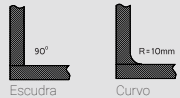

4.

CLOT ON TOP

44,9 x 28,3 cm

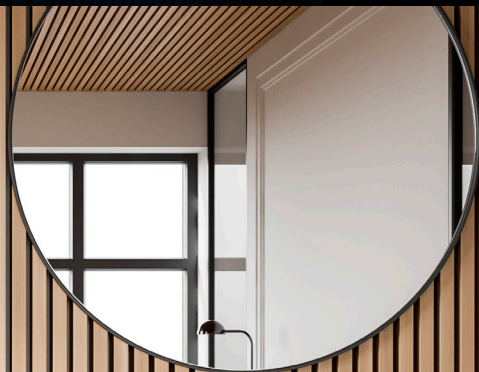

4.

CLOT ON TOP

44,9 x 28,3 cm



made with
KRICN

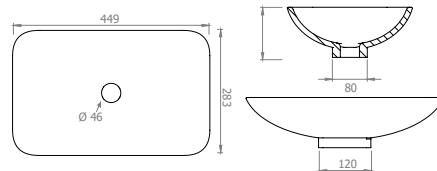

K-LIFE

On Top

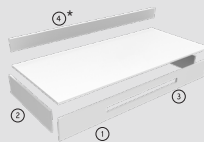
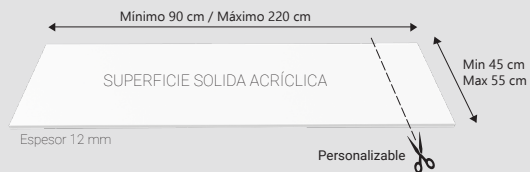
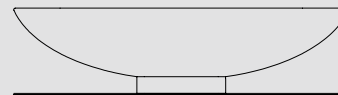

- ① Altura máxima 12 cm
- ② Altura máxima 12 cm
- ③ Toallero CNC 60 cm
- ④* Altura máxima 10 cm

④* Detalle





NOA

46,9 x 35 cm

4.



made with
KRICN

K-LIFE

NOA

46,9 x 35 cm

4.

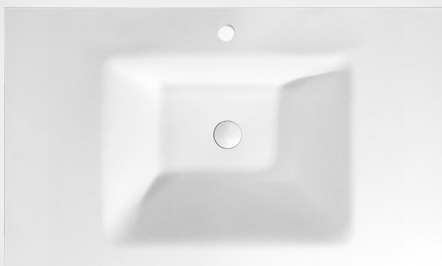
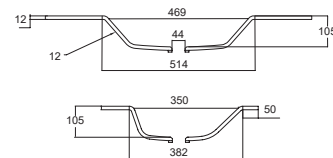
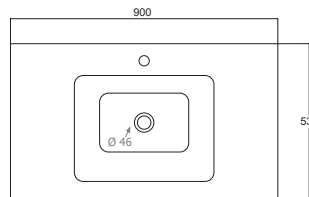

Centrado

Doble

Desplazado

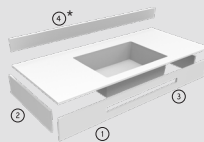
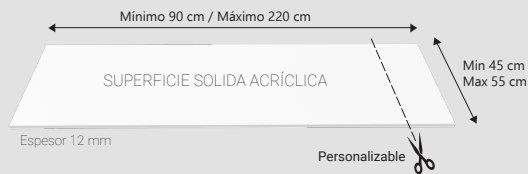

- ⊙ Altura máxima 12 cm
- ⊙ Altura máxima 12 cm
- ⊙ Toallero CNC 60 cm
- ⊙* Altura máxima 10 cm



⊙* Detalle



FUSION

51 x 31,5 cm

4.





made with
KRICON

FUSION

51 x 31,5 cm

4.

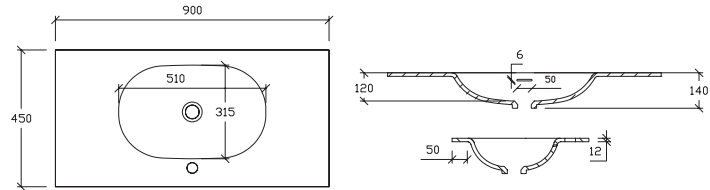

K-LIFE



Centrado

Doble

Desplazado

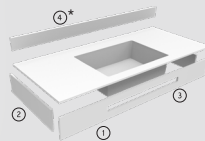
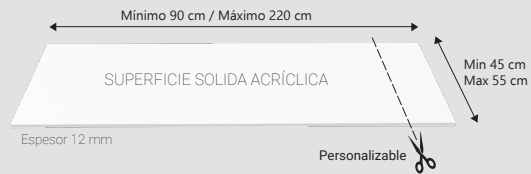

- ⊕ Altura máxima 12 cm
- ⊖ Altura máxima 12 cm
- ⊙ Toallero CNC 60 cm
- ⊕* Altura máxima 10 cm

⊕* Detalle

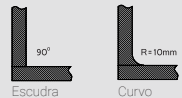



SLOW

42 x 42 cm

4.

4.

SLOW

42 x 42 cm



made with
KRICN

K-LIFE

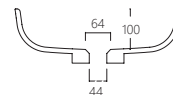
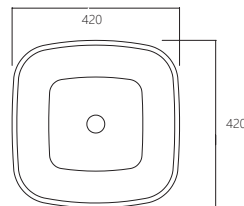

On Top

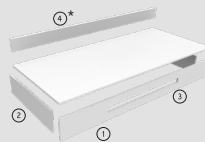
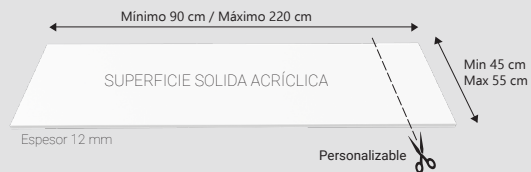
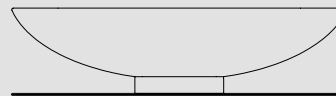

- ① Altura máxima 12 cm
- ② Altura máxima 12 cm
- ③ Toallero CNC 60 cm
- ④* Altura máxima 10 cm

④* Detalle



LAVABOS
ENCASTRADOS

LAVABOS

5.



vf Superficies
Sólidas[®]

Lavabos ESTÁNDAR



ESTÁNDAR

5.

3-WAY SERIES

⊖ **B210**
Ø40 cm



Profundidad: 12,5 cm

⊖ **B414**
60 x 40 cm



Profundidad: 12,5 cm

⊖ **B603**
40 x 40 cm



Profundidad: 12,5 cm

UNIQUE SERIES

⊖ **B604**
38 x 38 cm



Profundidad: 11 cm

⊖ **B812**
50 x 36 cm



Profundidad: 11,5 cm

⊖ **B814**
68 x 38 cm



Profundidad: 11 cm

SLANT SERIES

⊖ **B827**
38 x 28 cm New



Profundidad: 9,9 cm

⊖ **B828**
48 x 28 cm New



Profundidad: 9,9 cm

made with
KRION

⊖ Encastre

⊖ Con rebosadero interno.
No necesita kit externo.

SLIDE SERIES

⊖ **B416**
45 x 35 cm



Profundidad: 11,9 cm

⊖ **B821**
50 x 30 cm



Profundidad: 11,7 cm

⊖ **B822**
55 x 35 cm



Profundidad: 11,7 cm

ESTRUCTURA SIN LAVABO

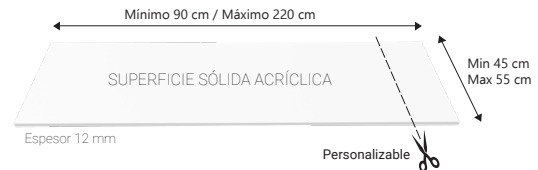



ESTÁNDAR

5.

BASIC SERIES

⊖ **B209**
D37 cm



Profundidad: 14 cm

⊖ **B413**
46 x 37 cm



Profundidad: 16,3 cm

⊖ **B415**
40 x 31 cm



Profundidad: 14 cm

⊖ **B417**
46 x 37 cm



⊖
Profundidad: 13,5 cm

⊖ **B810**
48 x 28 cm



Profundidad: 11,5 cm

⊖ **B811**
38 x 28 cm



Profundidad: 11,5 cm

⊖ **B817**
50 x 35 cm



Profundidad: 11,5 cm

⊖ **B819**
48 x 28 cm



⊖
Profundidad: 11,5 cm

⊖ **B820**
50 x 35 cm



⊖
Profundidad: 11,5 cm

⊖ **B823**
38 x 28 cm



⊖
Profundidad: 11,5 cm

LAVABOS PARA PERSONAS CON MOVILIDAD REDUCIDA

⊖ **D401**
43 x 35 cm



Profundidad: 7,8 cm

⊖ **D801**
48 x 28 cm



Profundidad: 7,8 cm

⊖ **D802**
48 x 28 cm



⊖
Profundidad: 7,8 cm

ESTRUCTURA SIN LAVABO

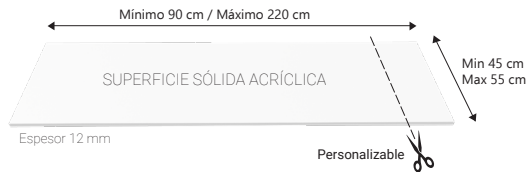

made with
Krion

⊖ Encastre

⊖ Con rebosadero interno.
No necesita kit externo.

ACCESORIOS

6.



vf Superficies
Sólidas

Accesorios lavabos



ACCESORIOS 6.

Grifería de solid surface SolitBath®

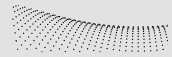
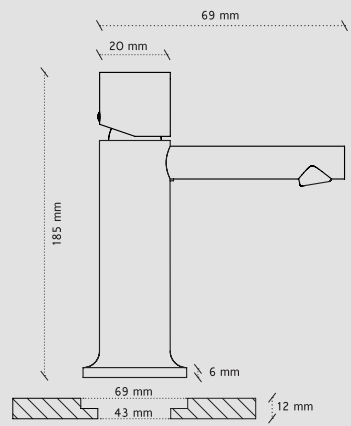
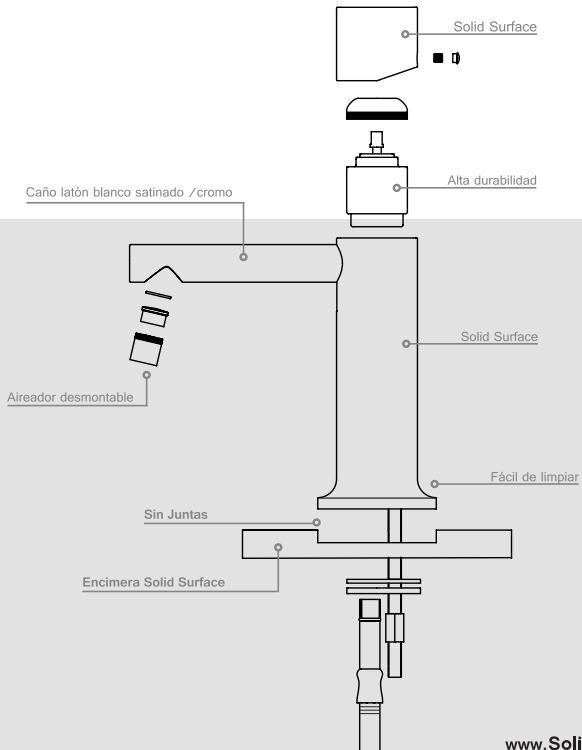

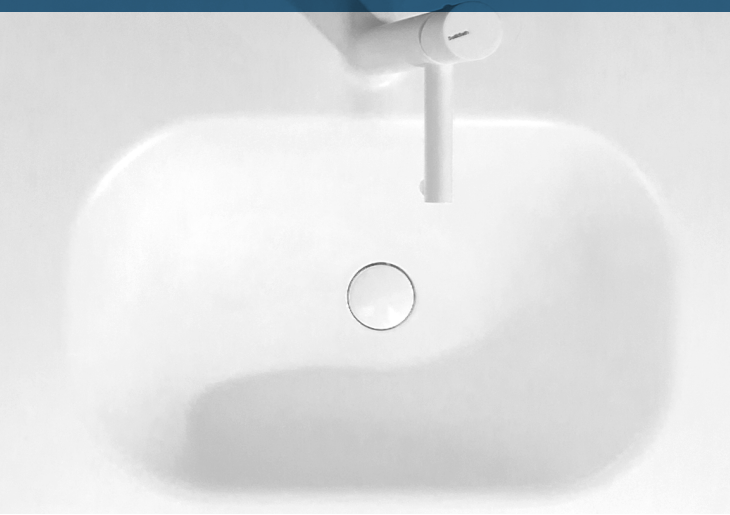

ACCESORIOS 6.



Big Bang Series
Caño Blanco



Big Bang Series
Caño Cromo



Lavabo Unidad



Rebosadero



Válvula Click
Clack Solid Surface



Escuadra Unidad



Toallero 40 x 3.5 cm

Escuadras sujección blancas pintura al horno



Escuadras de acero plegado de 2.5mm de espesor con acabado epoxi blanco, sin ningún tipo de soldadura.

Válvula Click-Clack Solid Surface

Abierto/ Open

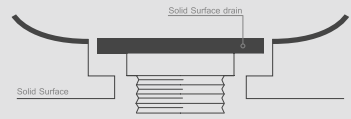

Cerrado/ Close

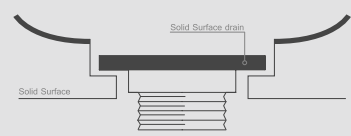

ACCESORIOS

6.

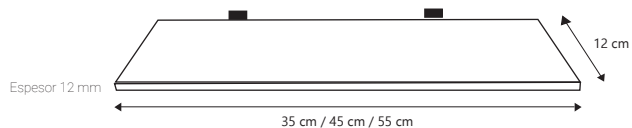
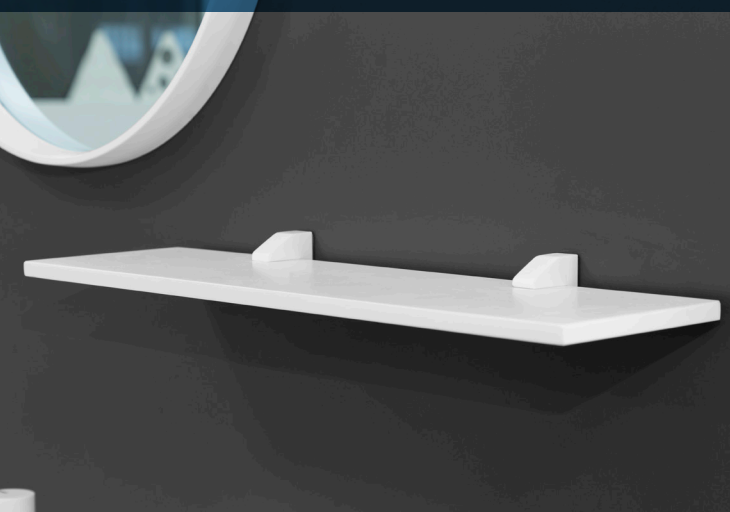

Balda recta



Soporte Pelican (Incluye 2 unidades por balda)

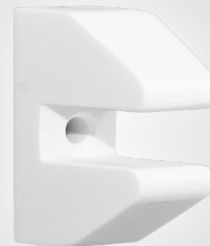

BAÑERAS
ENCASTRE

BAÑERAS

7.



vf Superficies
Sólidas

Bañeras ESTÁNDAR



UNIQUE

155 x 65 cm

7.

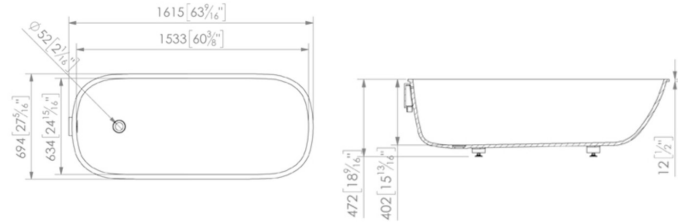

Características Técnicas

- Base de bañera semielaborada de encastre de 1534 x 634 mm y 402 mm de profundidad total.
- Incluye patas regulables en altura.
- Fabricado por molde mediante colada de Krion®.
- Incluye rebosadero externo y válvula de desagüe con tapa en color blanco.



made with
KRION



3-WAY

165 x 70 cm

7.

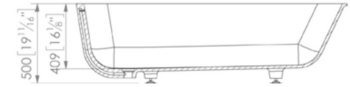
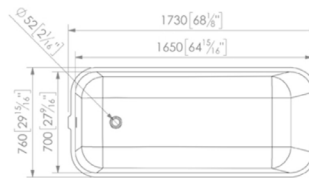

Características Técnicas



- Base de bañera semielaborada de encastre de 1650 x 700 mm y 410 mm de profundidad interior.

- Incluye patas regulables en altura.

- Fabricado por molde mediante colada de Krion®.

- Incluye rebosadero externo y válvula de desagüe con tapa en color blanco.

made with
KRION



BASIC

150 x 60 cm

7.

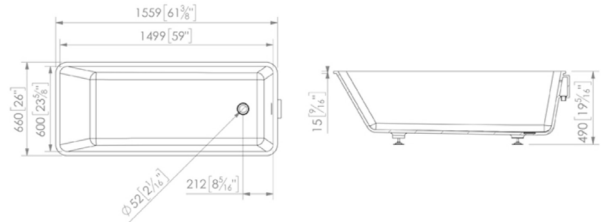

Características Técnicas



- Base de bañera semielaborada de encastre de 1499 x 600 mm y 410 mm de profundidad total.
- Incluye patas regulables en altura.
- Fabricado por molde mediante colada de Krion®.
- Incluye rebosadero externo y válvula de desagüe con tapa en color blanco.

made with
KRION



BABYBATH

70 x 42 cm

7.

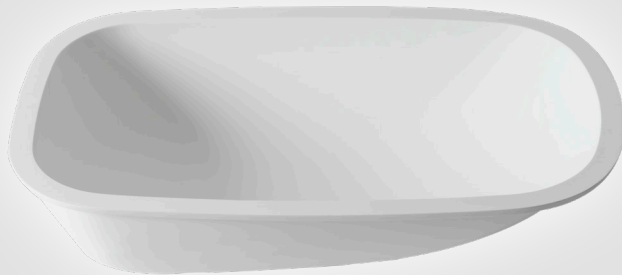
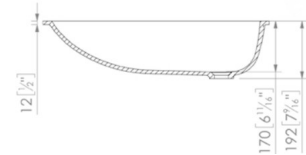
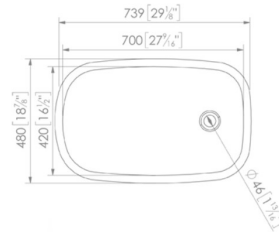

Características Técnicas

- Base de bañera de encastre de 700 x 420 mm y 169 mm de profundidad interior.
- Fabricado por molde mediante colada de Krion®.
- No incluye rebosadero.
- Incluye válvula de desagüe con tapa en color blanco.

made with
KRION



vf® Superficies
Sólidas



www.vfaplicaciones.es



Realizar pedido